

- * 1 : Shielded
- * 2 : w/ Trailer Towing
- * 3 : w/o Trailer Towing

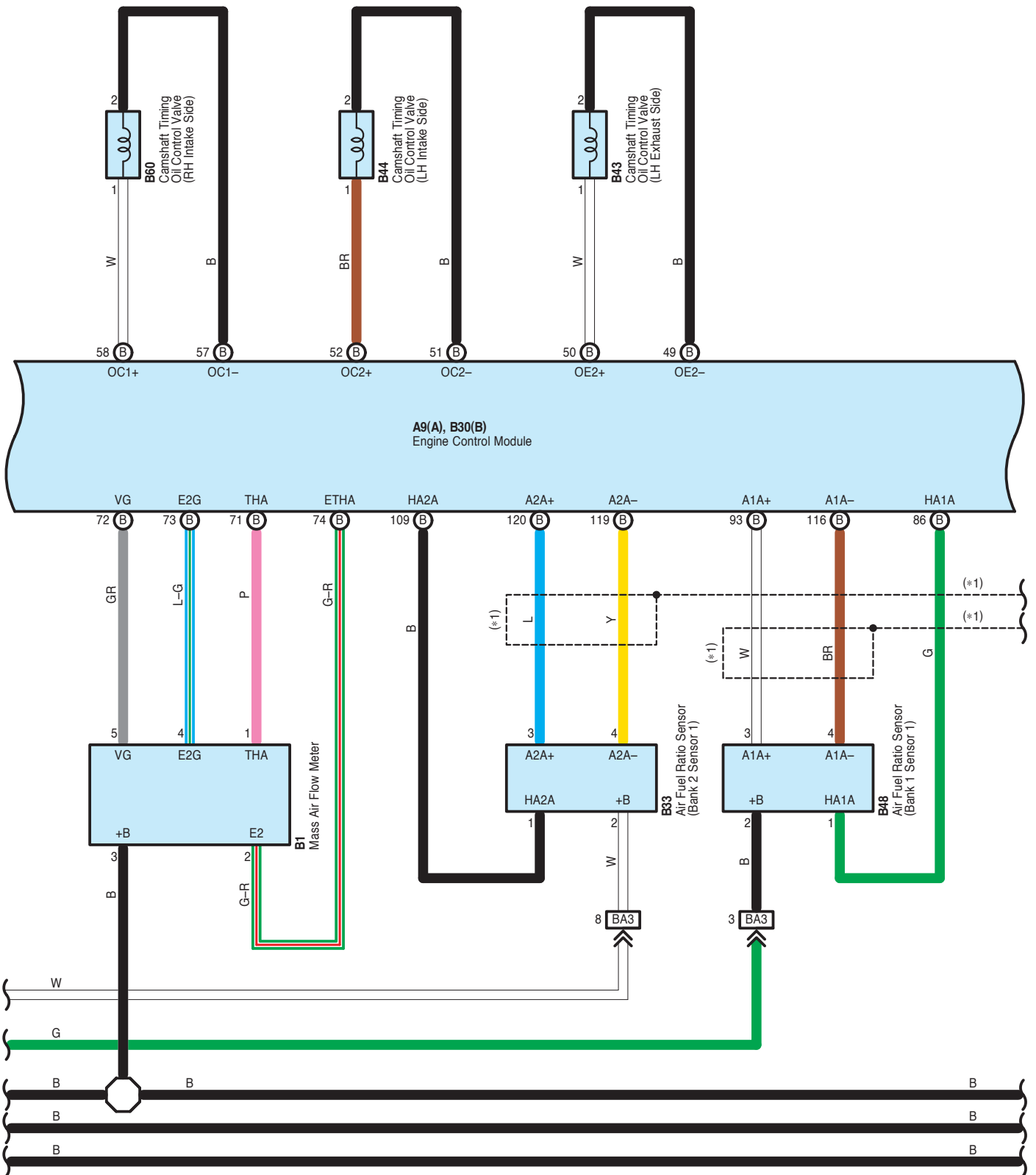

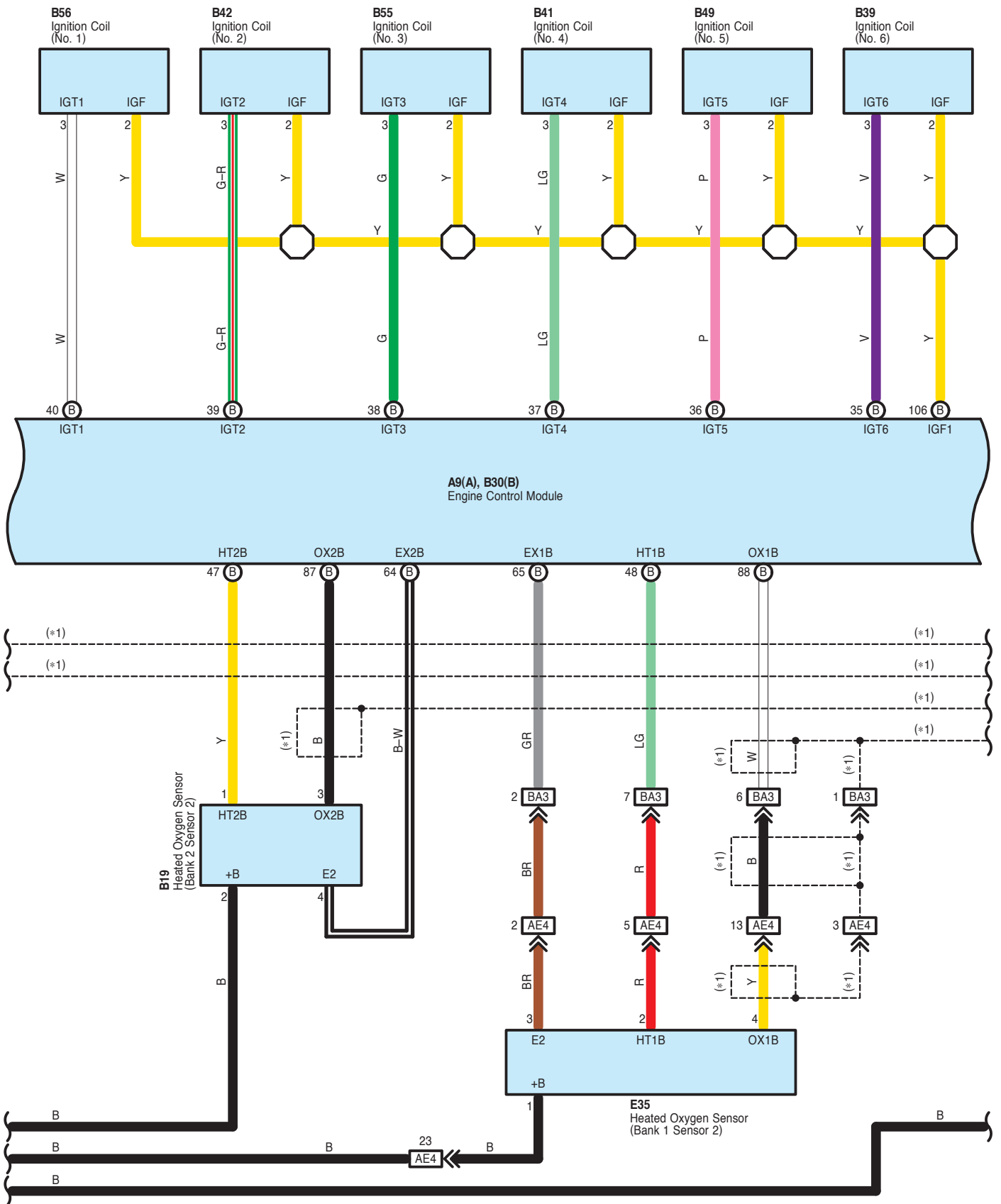

* 1 : Shielded

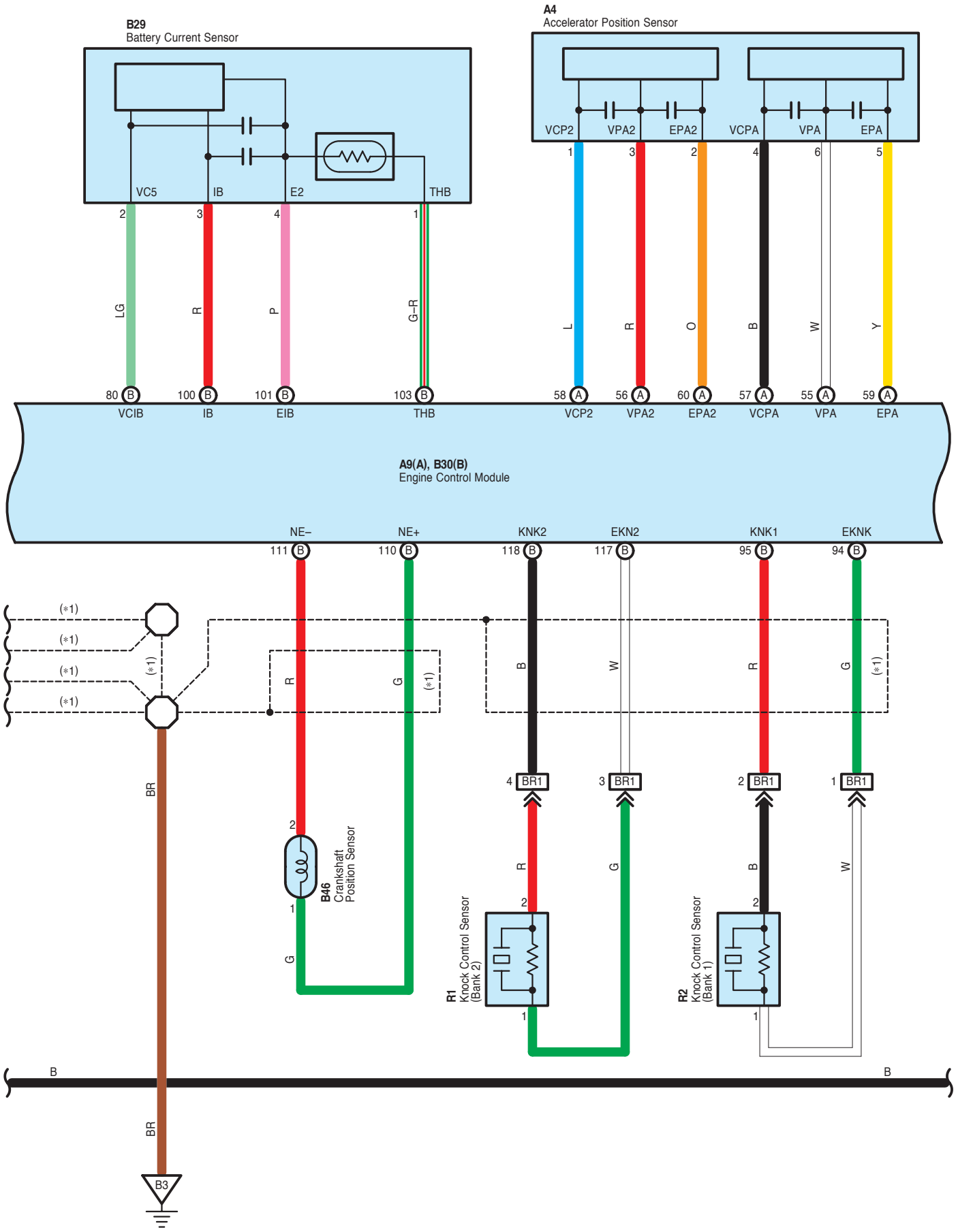

Engine Control <2GR-FE>

- * 2 : w/ Trailer Towing
- * 3 : w/o Trailer Towing
- * 4 : w/ Power Outlet (115V)
- * 5 : w/o Power Outlet (115V)

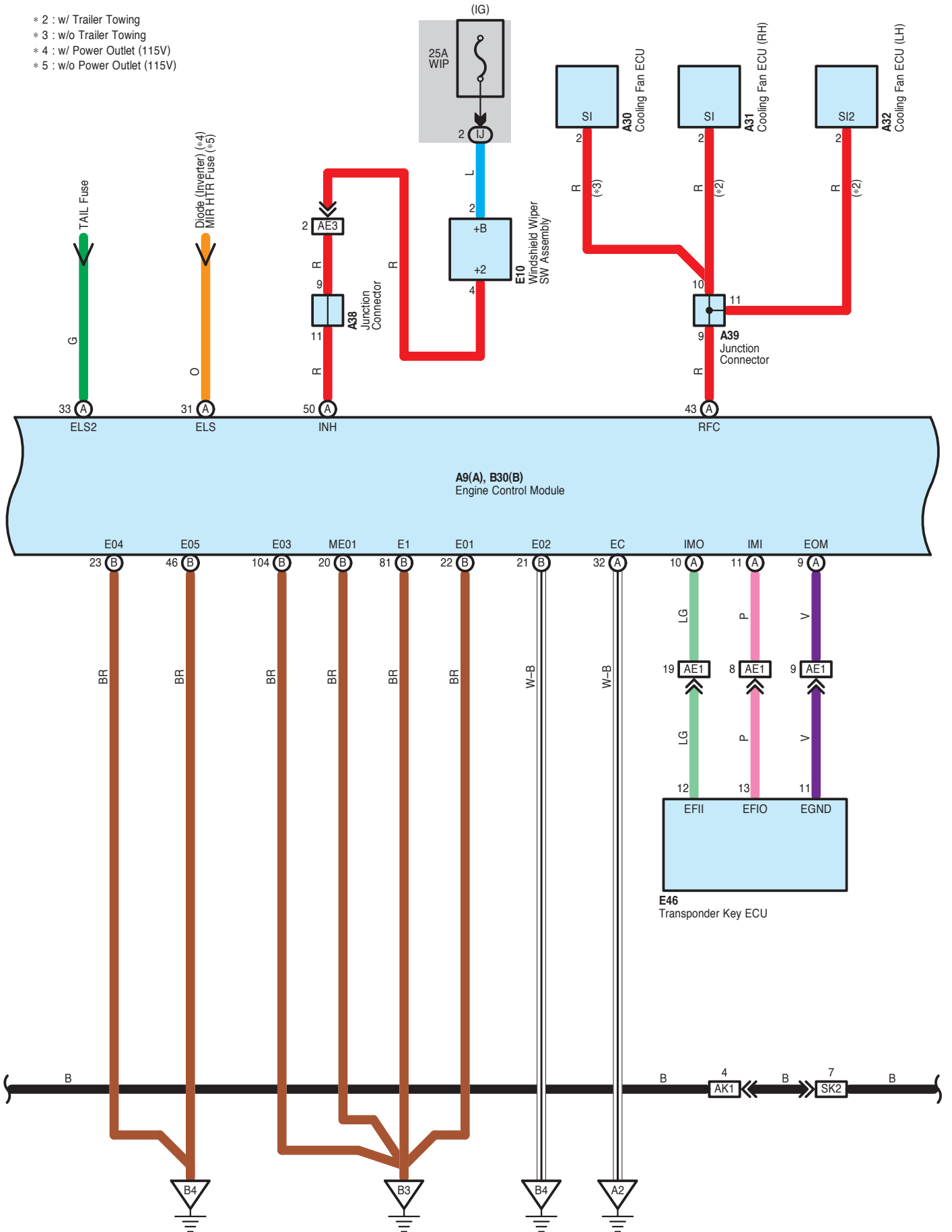

Engine Control <2GR-FE>

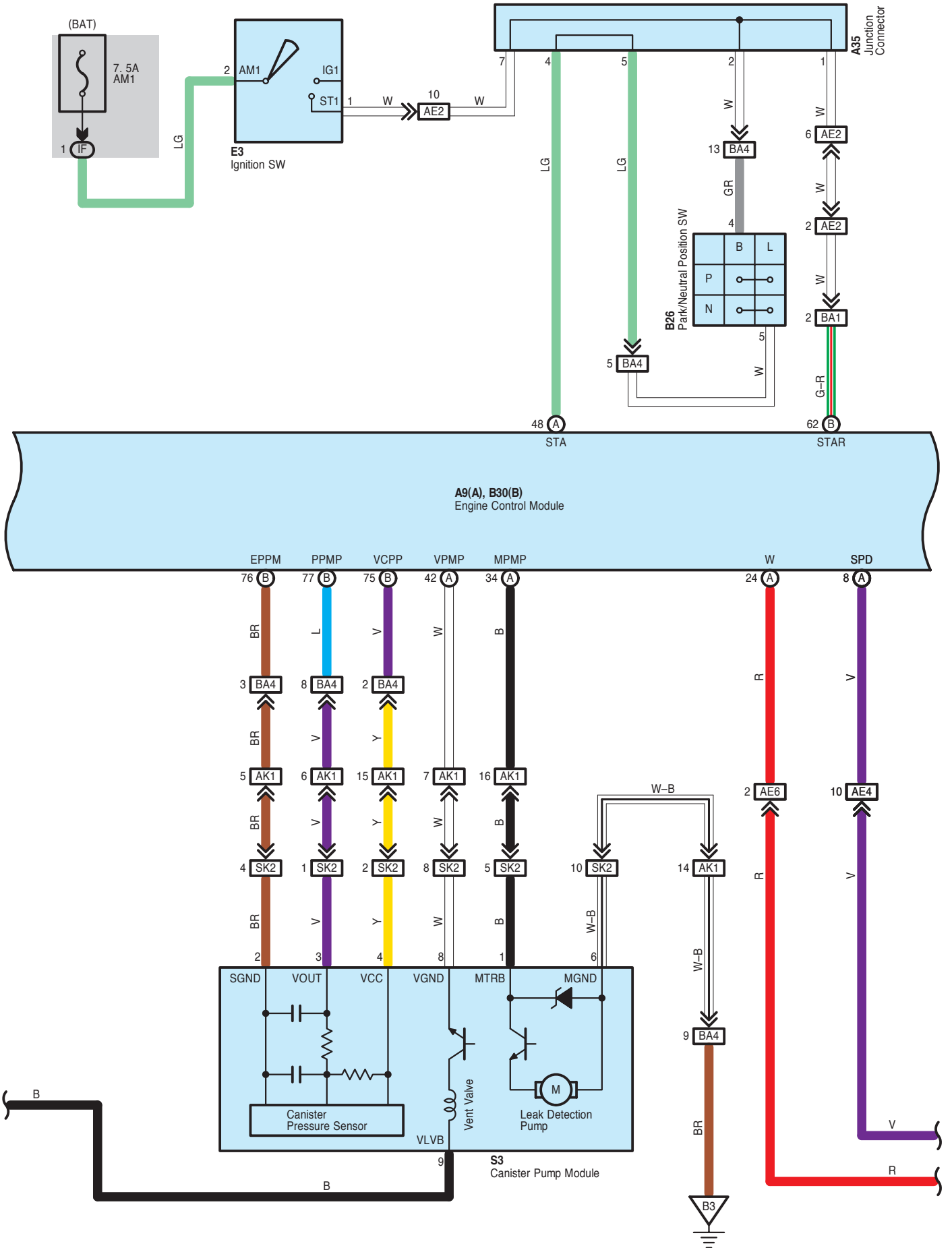

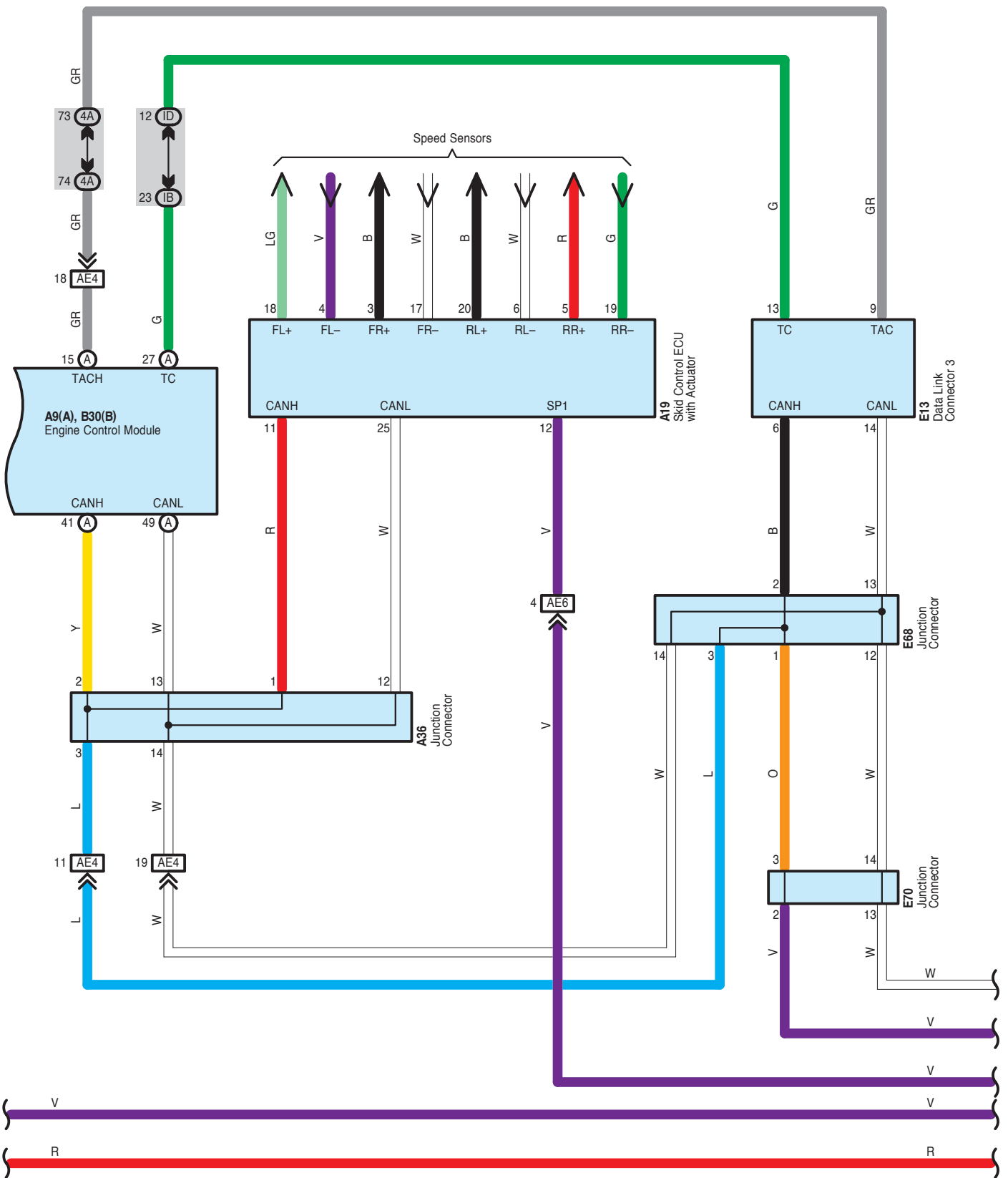

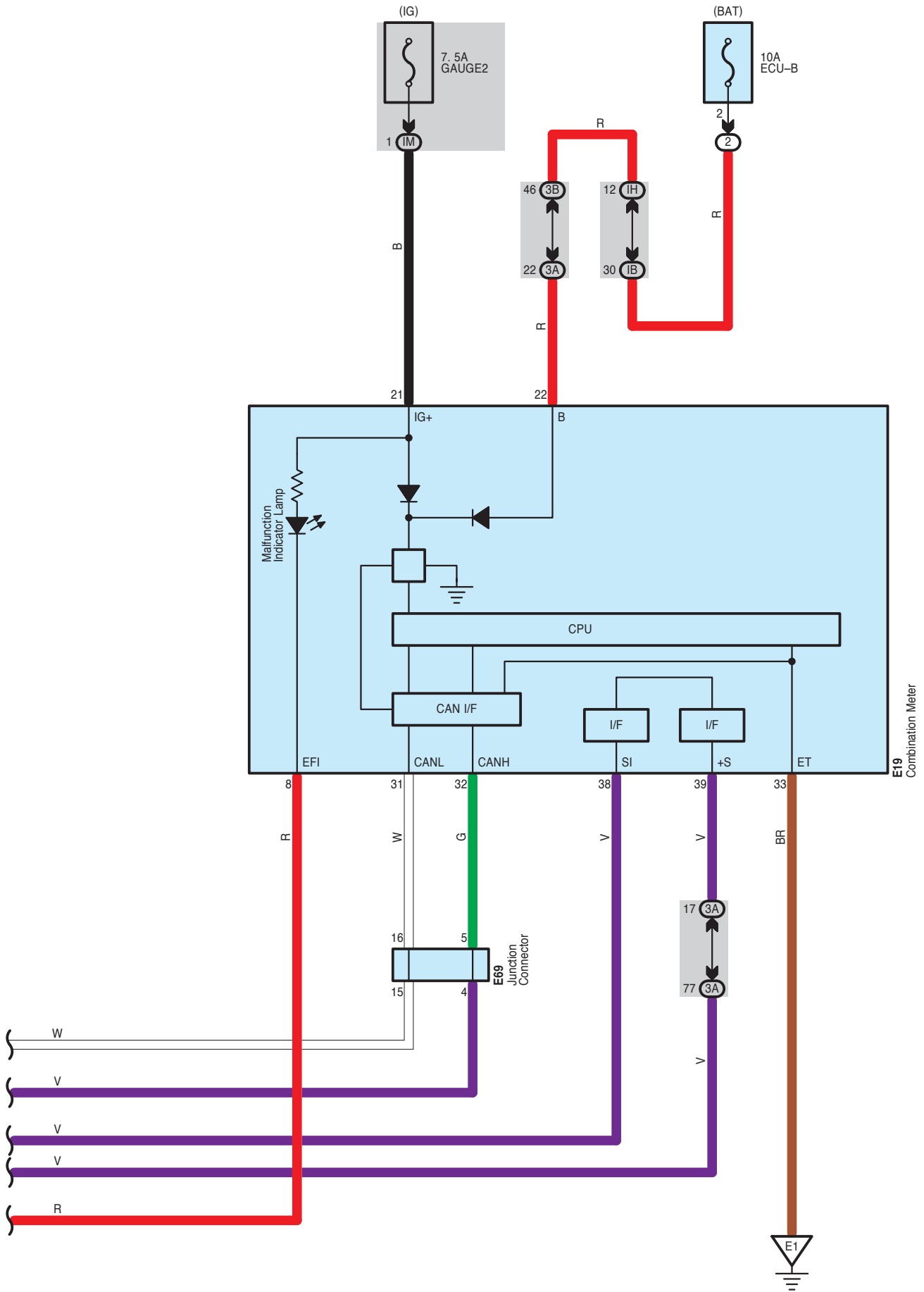

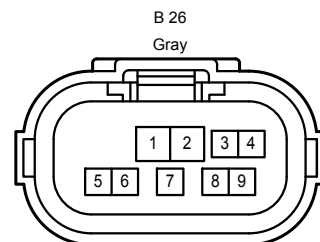
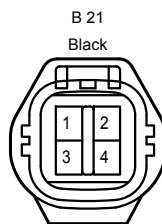
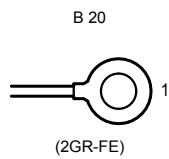
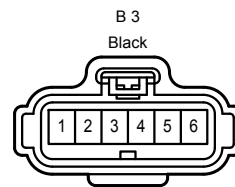
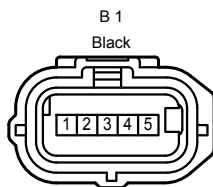
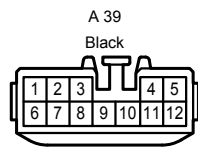
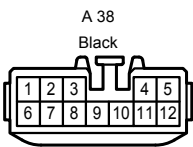
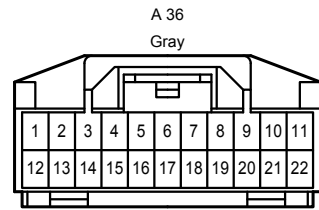
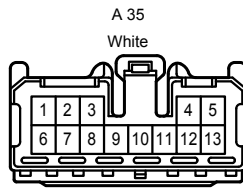
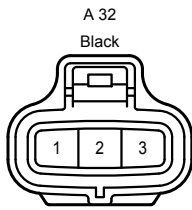
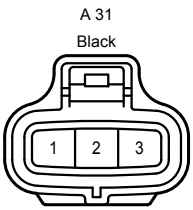
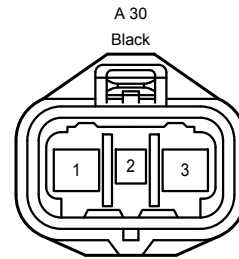
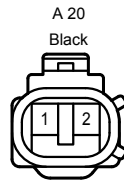
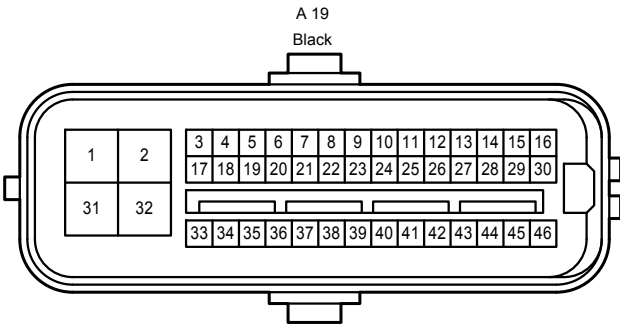
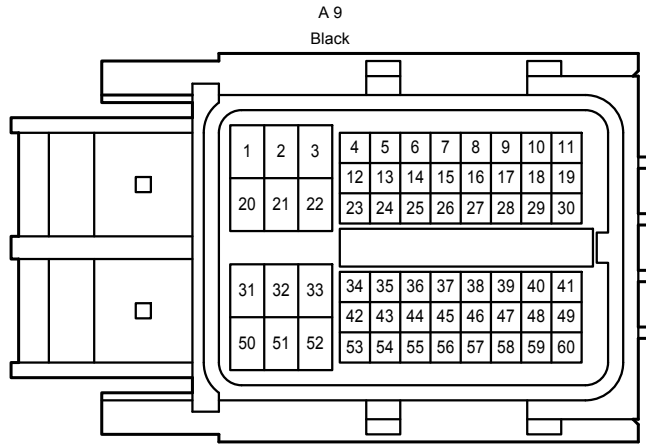
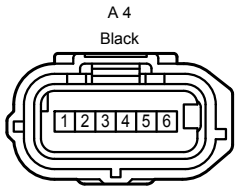
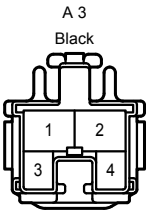

Engine Control <2GR-FE>

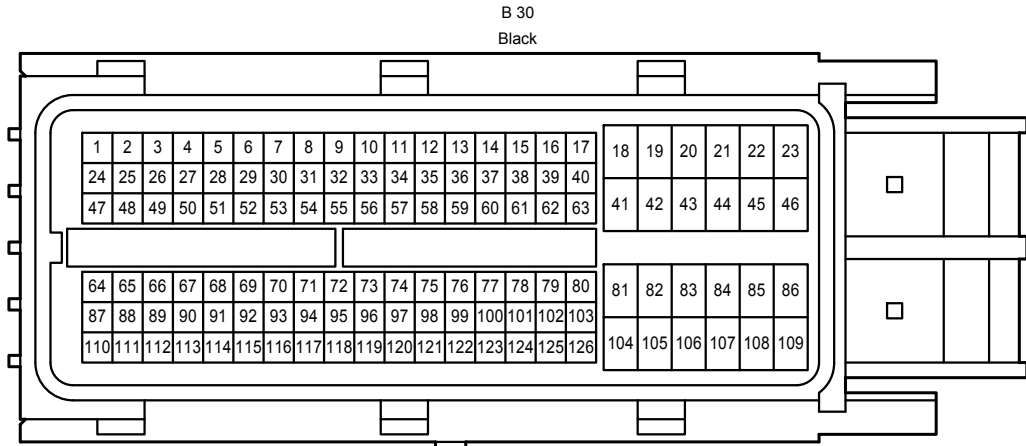
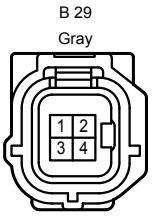

(2GR-FE)

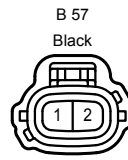
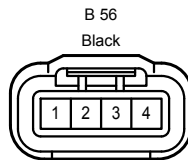
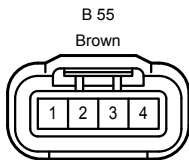
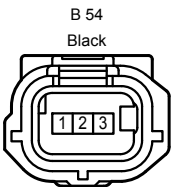
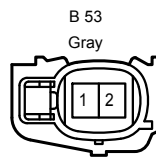
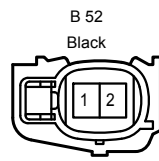
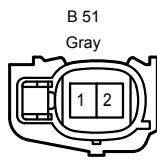
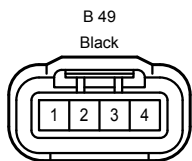
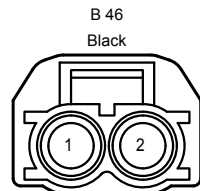
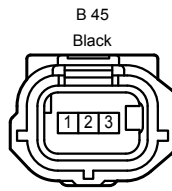
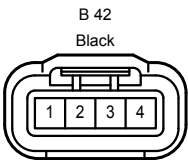
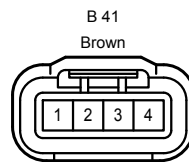
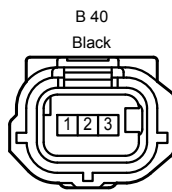
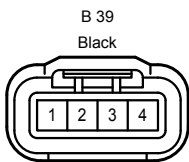
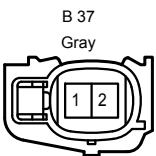
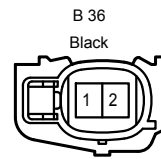
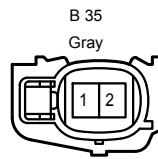
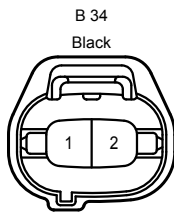
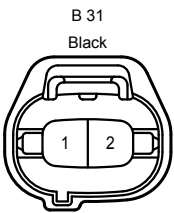

Engine Control <2GR-FE>

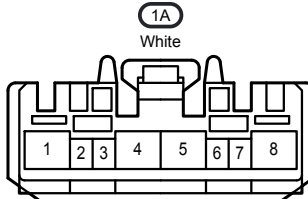
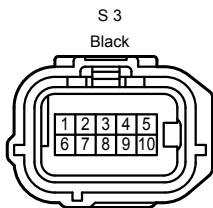
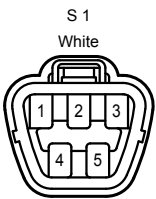
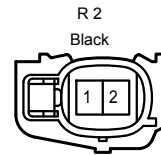
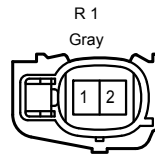
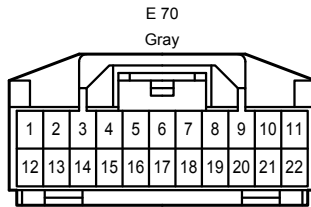
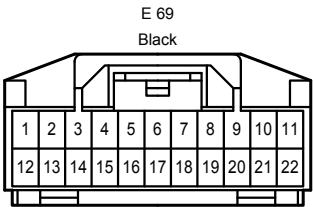
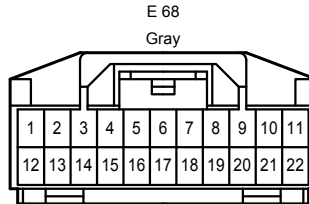
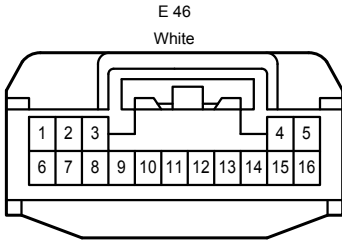
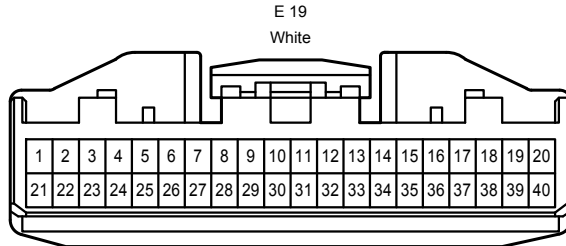
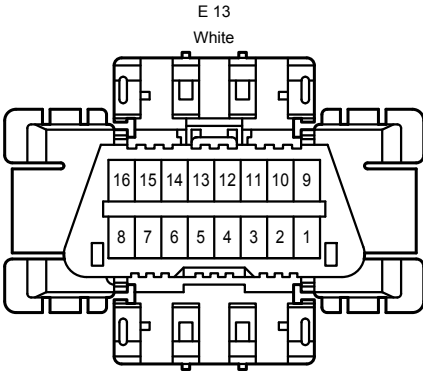
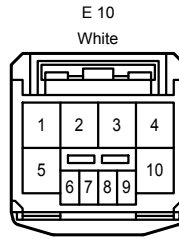
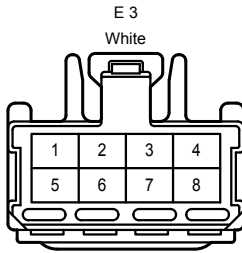
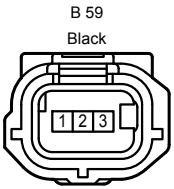

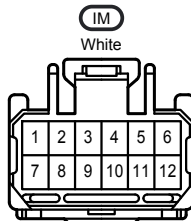
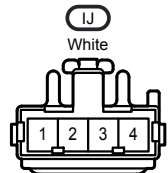
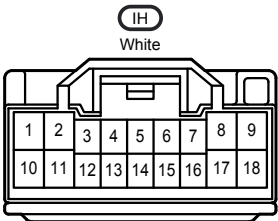
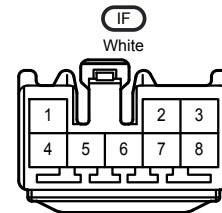
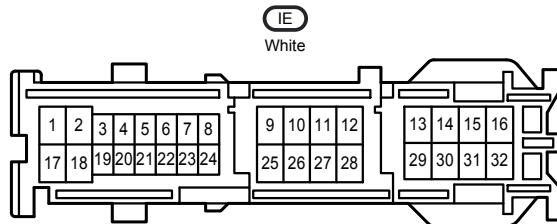
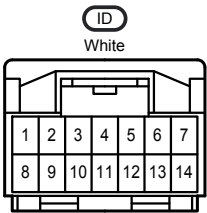
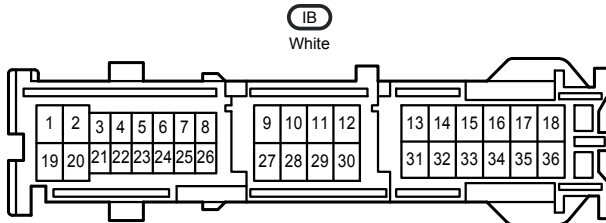
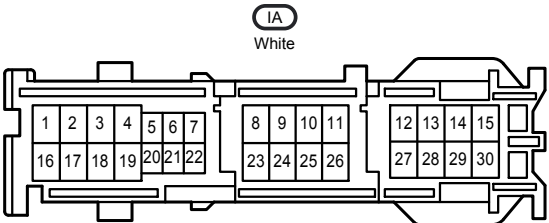
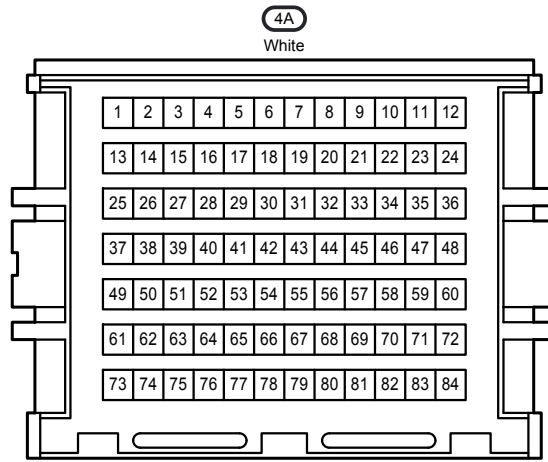
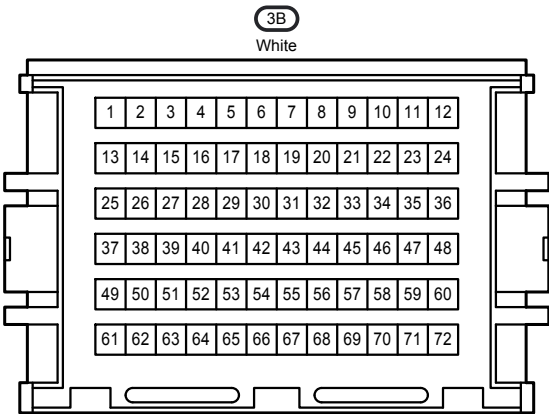
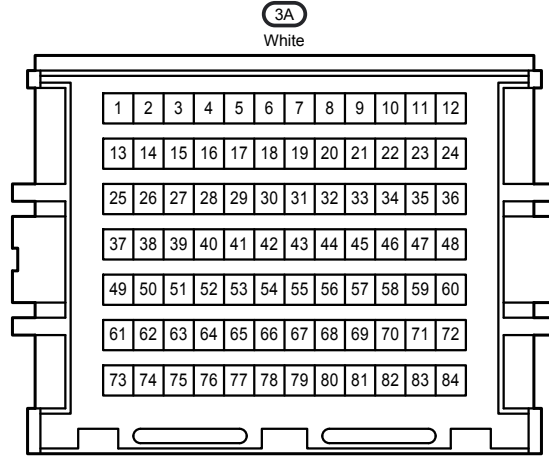
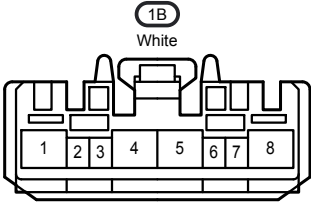

AE1
White

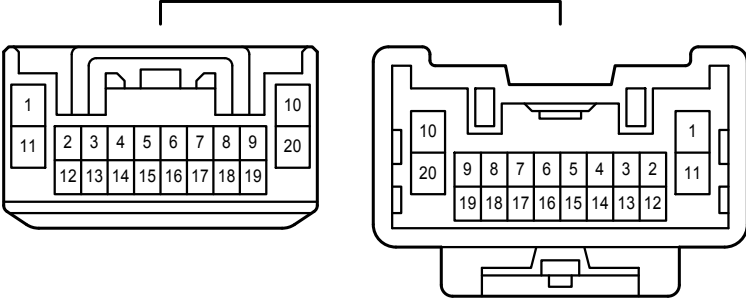

AE2
White

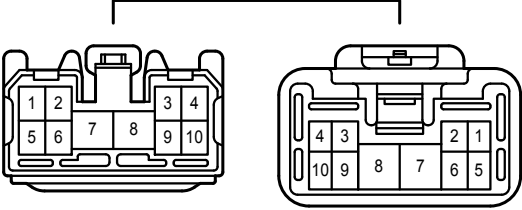

AE3
Black

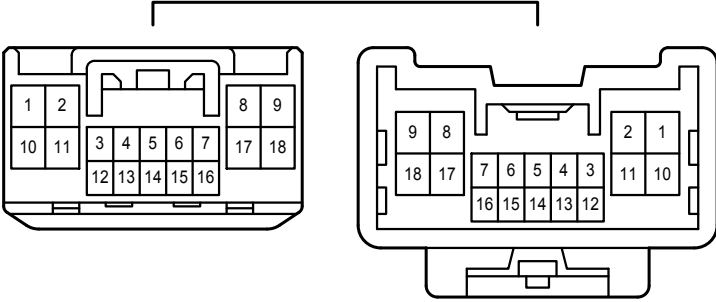

AE4
Gray

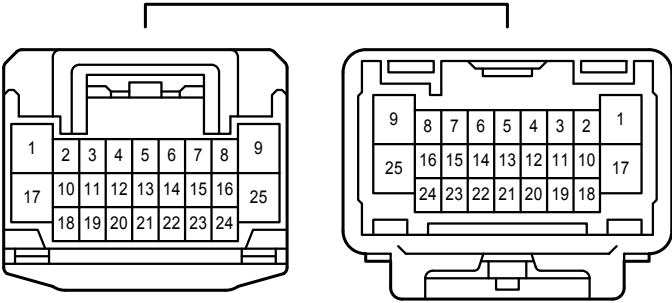

AE6
White

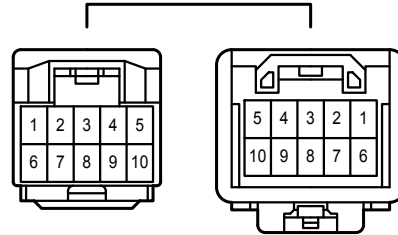

AK1
White

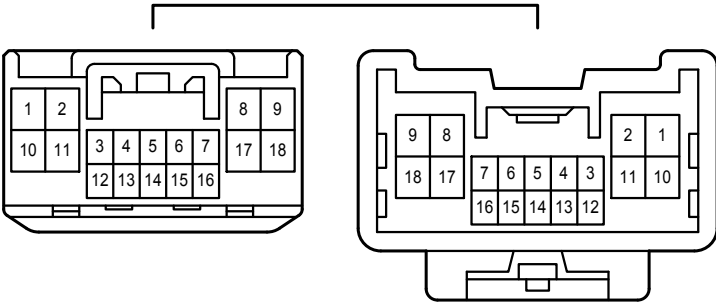

BA1
White

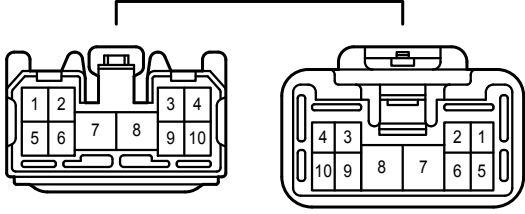

BA3
White

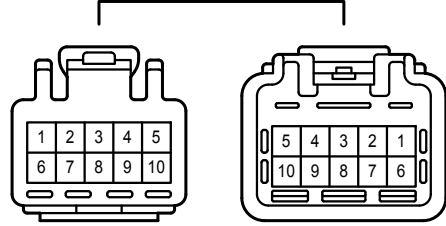

BA4
Gray

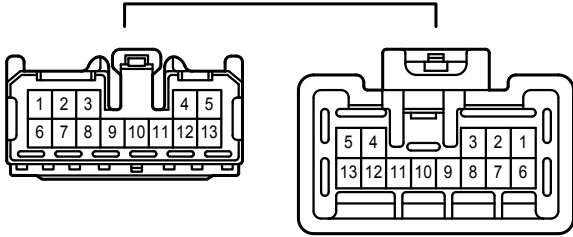

BR1
Gray

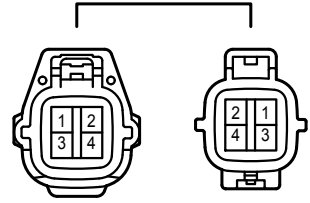

SK1
White

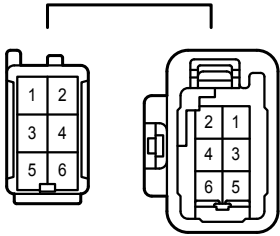

SK2
Black

